



S H A P E
of LIGHT

ready-made solutions



S H A P E *of* LIGHT

ready-made solutions

Welcome to a world where minimalist design meets bright radiance. In this catalogue we present a line of ready-made indoor luminaires,

meticulously crafted to embody the timeless beauty of Scandinavian-inspired design, with their clean lines, organic forms, and refined elegance.

Designed to illuminate large and spacious spaces, these luminaires are sure to meet the most demanding lighting challenges.

We understand the challenges that can be faced in lighting vast areas. That's why every luminaire in this collection has been designed using the latest technology to produce high intensity light that illuminates every corner of the room.

In this catalogue you will find a vast array of ready-made light panels, including their basic technical parameters and available customisation options. In this catalogue,

PURE LIGHTING

Vecta Design offers a wide range of solutions for optimising workplace lighting to achieve the desired light intensity and LUX levels. We use reliable quality lighting elements that provide high quality light, uniform illumination without shadows, high efficiency and the desired light temperature. If required, our panels can provide a full colour spectrum with a high CRI.

HOUSING

Our range of luminaires is meticulously crafted from white painted aluminium profile, expertly bent and cut with precision. Each luminaire is hand-finished and painted with great care and attention to detail.

Each panel is available in two depths - 118 mm and 200 mm - for versatility and adaptation to different design challenges.

FLEXIBLE LIGHT DIFFUSER

We use a soft thermoelastic material for light diffusion. It has excellent light transmission and diffusion properties, giving the most homogeneous soft effect. It offers an ideal smoothness and straightness of the coating. The different widths of the material allow the creation of large light panels without visual divisions and seams in the middle. It is durable and tear resistant (withstands pressure up to 100 kg/m²), safe and light material (only

0.18 to 0.2 mm in thickness). It does not accumulate static electricity and therefore does not collect dust on the front, does not warp and retains its colour.

We also add a protective layer to the inside of the panel to protect against dust and possible organic inclusions.

ACOUSTIC SOLUTIONS

Excessive noise can cause stress, loss of productivity in the workplace, communication difficulties and fatigue due to lack of sleep. Noise pollution is a serious health issue that deserves our attention. Soundproofing solutions are a simple, elegant and an effective way to improve the acoustic quality of any space. We offer panels with maximum, Class A, sound absorbing qualities.

FIRE PERFORMANCE BS-1D0, BS-2D0

We test our products on a regular basis. They meet the fire and electrical safety and quality standards set by industry regulations and certifications. Our commitment to rigorous testing ensures that our products not only meet but exceed the highest safety standards, giving you peace of mind and confidence in their reliability.

GREEN BUILDING

We are proud that our products meet the high requirements of standardized norms for environmental friendliness, durability and non-toxicity of materials. By carefully selecting materials and adhering to standard norms, we strive to create products that not only visually improve the internal environment, but also guarantee the health and well-being of those who live in it.



CIRCLE

Circle is a luminaire that embodies simplicity and harmony with its rounded geometry. An aluminium profile is expertly bent into a ring shape, creating a sleek and seamless design. The circular ceiling fixture casts a soft and even glow, adding a touch of warmth to any space. The shape is ideal for any room. With high ceilings, this versatile luminaire can be combined in multi-level compositions, offering creative design solutions.

- HOUSING:** White aluminium luminaire, flexible translucent diffuser. Direct light distribution. High luminous efficiency. Level of illumination is uniform over the entire surface.
- MOUNTING:** 3 installation options, power supply mounted within the housing.
- LAMPING:** LED-technology 24V, CRI > 90.

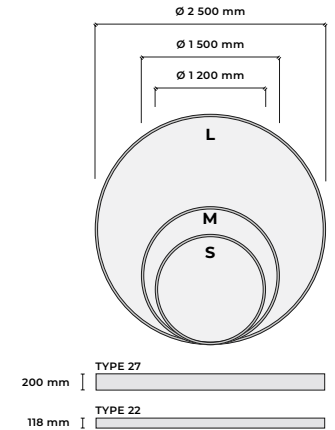

LUMINAIRE VARIATIONS

TYPE 27	TYPE 22
HIGH FLUX (WW / NW / TW)	MEDIUM FLUX (WW / NW)
h = 200 mm	h = 118 mm

* ACOUSTIC

LED SPECIFICATION

LIGHT SOURCE	COLOR TEMP	CRI (RA)
Warm White (WW)	3 000 K	> 90
Neutral White (NW)	4 000 K	> 90
Tunable White (TW)*	2 700 - 6 500 K	> 90

DIMENSIONS	TYPE 27		TYPE 22	
	HIGH FLUX (for NW)	POWER CONSUMPTION	MEDIUM FLUX (for NW)	POWER CONSUMPTION
S Ø 1 200 mm	≈ 14 476 LM	226 W	≈ 6 211 LM	100 W
M Ø 1 500 mm	≈ 22 963 LM	359 W	≈ 9 379 LM	150 W
L Ø 2 500 mm	≈ 61 400 LM	959 W	≈ 26 796 LM	429 W

FEATURES:

- HOUSING COLOR** white
- CONTROL PROTOCOL** dimming 0/1-10 V
- LED CT** WW / NW / TW*

OPTIONAL:

- SIZE** unlimited
- CONTROL PROTOCOL** DALI 2, DMX*
- LED CT** 5 000 K, 6 000 K, RGBW*
- ADDITIONAL** acoustic features*, remote control or switch, RAL coating, diffuser print

* options for High Luminous Flux Luminaires Type 27 (h = 200 mm)





POLO

A luminaire with an elongated, rounded shape that seamlessly combines elegant simplicity and functionality in its design. With its calm appearance, Polo adds a touch of sophisticated beauty to any space. The shape of the luminaire creates a visually appealing focal point, while its clean lines and smooth curves evoke a sense of modernity and lightness. Whether used in offices, hotels or residential spaces, Polo provides a balanced and pleasant lighting experience, enhancing visibility and comfort.

- HOUSING:** White aluminium luminaire, flexible translucent diffuser. Direct light distribution. High luminous efficiency. Level of illumination is uniform over the entire surface.
- MOUNTING:** 3 installation options, power supply mounted within the housing.
- LAMPING:** LED-technology 24V, CRI > 90.

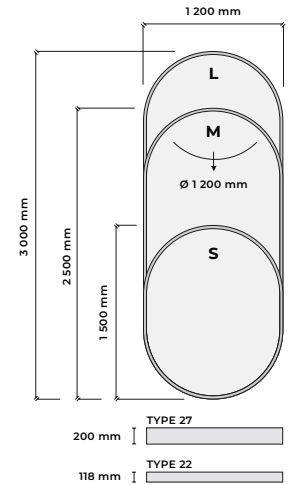

LUMINAIRE VARIATIONS

TYPE 27	TYPE 22
HIGH FLUX (WW / NW / TW)	MEDIUM FLUX (WW / NW)
h = 200 mm	h = 118 mm

*ACOUSTIC

LED SPECIFICATION

LIGHT SOURCE	COLOR TEMP	CRI (RA)
Warm White (WW)	3 000 K	> 90
Neutral White (NW)	4 000 K	> 90
Tunable White (TW)*	2 700 - 6 500 K	> 90

DIMENSIONS	TYPE 27		TYPE 22	
	HIGH FLUX (for NW)	POWER CONSUMPTION	MEDIUM FLUX (for NW)	POWER CONSUMPTION
S 1 200 x 1 500 mm	≈ 19 468 LM	304 W	≈ 8 404 LM	135 W
M 1 200 x 2 500 mm	≈ 34 444 LM	538 W	≈ 14 981 LM	240 W
L 1 200 x 3 000 mm	≈ 41 932 LM	655 W	≈ 18 270 LM	293 W

FEATURES:

- HOUSING COLOR** white
- CONTROL PROTOCOL** dimming 0/1 - 10 V
- LED CT** WW / NW / TW*

OPTIONAL:

- SIZE** unlimited
- CONTROL PROTOCOL** DALI 2, DMX*
- LED CT** 5 000 K, 6 000 K, RGBW*
- ADDITIONAL** acoustic features*, remote control or switch, RAL coating, diffuser print

* options for High Luminous Flux Luminaires Type 27 (h = 200 mm)





STEP

Step is a square luminaire designed to bring simplicity and even lighting to any space. With its clean and minimalist design, it blends seamlessly into various environments, making it a versatile lighting solution. Thanks to its square shape, Step creates a symmetrical and harmonious light, spreading a uniform flow of light throughout the room.

- HOUSING:** White aluminium luminaire, flexible translucent diffuser. Direct light distribution. High luminous efficiency. Level of illumination is uniform over the entire surface.
- MOUNTING:** 3 installation options, power supply mounted within the housing.
- LAMPING:** LED-technology 24V, CRI > 90.

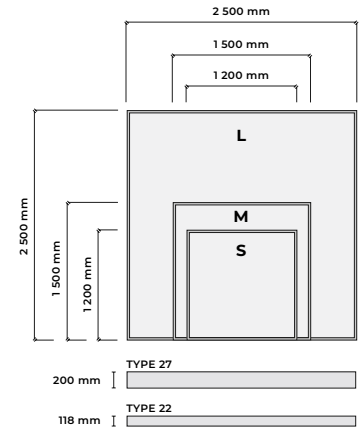

LUMINAIRE VARIATIONS

TYPE 27	TYPE 22
HIGH FLUX (WW / NW / TW)	MEDIUM FLUX (WW / NW)
h = 200 mm	h = 118 mm

* ACOUSTIC

LED SPECIFICATION

LIGHT SOURCE	COLOR TEMP	CRI (RA)
Warm White (WW)	3 000 K	> 90
Neutral White (NW)	4 000 K	> 90
Tunable White (TW)*	2 700 - 6 500 K	> 90

DIMENSIONS	TYPE 27		TYPE 22	
	HIGH FLUX (for NW)	POWER CONSUMPTION	MEDIUM FLUX (for NW)	POWER CONSUMPTION
S 1 200 x 1 200 mm	≈ 17 472 LM	273 W	≈ 7 673 LM	123 W
M 1 500 x 1 500 mm	≈ 26 956 LM	420 W	≈ 12 058 LM	194 W
L 2 500 x 2 500 mm	≈ 74 880 LM	1 170 W	≈ 36 540 LM	585 W

FEATURES:

- HOUSING COLOR** white
- CONTROL PROTOCOL** dimming 0/1-10 V
- LED CT** WW / NW / TW*

OPTIONAL:

- SIZE** unlimited
- CONTROL PROTOCOL** DALI 2, DMX*
- LED CT** 5 000 K, 6 000 K, RGBW*
- ADDITIONAL** acoustic features*, remote control or switch, RAL coating, diffusor print

* options for High Luminous Flux Luminaires Type 27 (h = 200 mm)





ACCORD

Accord is a rectangular luminaire designed to illuminate modern interiors. Combining elegance and functionality, Accord has a simple yet stylish design that fits perfectly in any large room. This luminaire distributes light evenly and uniformly across its entire surface, providing balanced illumination with no dark spots or shadows. The homogeneous light enhances visual comfort and creates a harmonious ambience.

- HOUSING:** White aluminium luminaire, flexible translucent diffuser. Direct light distribution. High luminous efficiency. Level of illumination is uniform over the entire surface.
- MOUNTING:** 3 installation options, power supply mounted within the housing.
- LAMPING:** LED-technology 24V, CRI > 90.

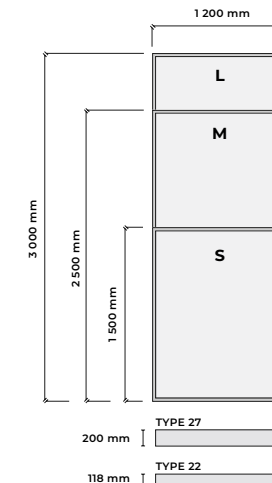

LUMINAIRE VARIATIONS

TYPE 27	TYPE 22
HIGH FLUX (WW / NW / TW)	MEDIUM FLUX (WW / NW)
h = 200 mm	h = 118 mm

* ACOUSTIC

LED SPECIFICATION

LIGHT SOURCE	COLOR TEMP	CRI (RA)
Warm White (WW)	3 000 K	> 90
Neutral White (NW)	4 000 K	> 90
Tunable White (TW)*	2 700 - 6 500 K	> 90

DIMENSIONS	TYPE 27		TYPE 22	
	HIGH FLUX (for NW)	POWER CONSUMPTION	MEDIUM FLUX (for NW)	POWER CONSUMPTION
S 1 200 x 1 500 mm	≈ 22 464 LM	350 W	≈ 9 865 LM	157 W
M 1 200 x 2 500 mm	≈ 37 440 LM	585 W	≈ 16 443 LM	263 W
L 1 200 x 3 000 mm	≈ 44 928 LM	700 W	≈ 19 731 LM	316 W

FEATURES:

- HOUSING COLOR** white
- CONTROL PROTOCOL** dimming 0/1 - 10 V
- LED CT** WW / NW / TW*

OPTIONAL:

- SIZE** unlimited
- CONTROL PROTOCOL** DALI 2, DMX*
- LED CT** 5 000 K, 6 000 K, RGBW*
- ADDITIONAL** acoustic features*, remote control or switch, RAL coating, diffuser print

* options for High Luminous Flux Luminaires Type 27 (h = 200 mm)





TEMPO

Tempo is a luminaire of square shape with rounded corners that illuminates your space with a wide and encompassing glow. An important feature of our lamps is their high light output. Thanks to the use of special technologies and quality LED light sources, Tempo provides bright and pleasant lighting, creating a comfortable atmosphere and ensuring good visibility at any time of day.

- HOUSING:** White aluminium luminaire, flexible translucent diffuser. Direct light distribution. High luminous efficiency. Level of illumination is uniform over the entire surface.
- MOUNTING:** 3 installation options, power supply mounted within the housing.
- LAMPING:** LED-technology 24V, CRI > 90.

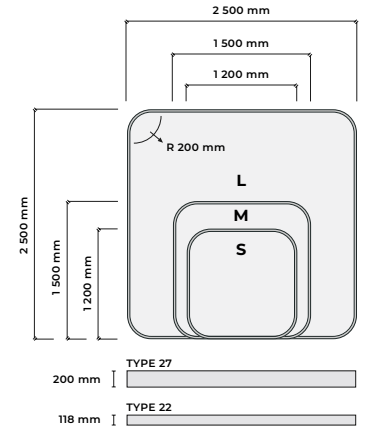

LUMINAIRE VARIATIONS

TYPE 27	TYPE 22
HIGH FLUX (WW / NW / TW)	MEDIUM FLUX (WW / NW)
h = 200 mm	h = 118 mm

* ACOUSTIC

LED SPECIFICATION

LIGHT SOURCE	COLOR TEMP	CRI (RA)
Warm White (WW)	3 000 K	> 90
Neutral White (NW)	4 000 K	> 90
Tunable White (TW)*	2 700 - 6 500 K	> 90

DIMENSIONS	TYPE 27		TYPE 22	
	HIGH FLUX (for NW)	POWER CONSUMPTION	MEDIUM FLUX (for NW)	POWER CONSUMPTION
S 1 200 x 1 200 mm	≈ 16 473 LM	257 W	≈ 7 430 LM	120 W
M 1 500 x 1 500 mm	≈ 25 958 LM	405 W	≈ 11 815 LM	190 W
L 2 500 x 2 500 mm	≈ 73 880 LM	1 154 W	≈ 36 295 LM	580 W

FEATURES:

- HOUSING COLOR** white
- CONTROL PROTOCOL** dimming 0/1 - 10 V
- LED CT** WW / NW / TW*

OPTIONAL:

- SIZE** unlimited
- CONTROL PROTOCOL** DALI 2, DMX*
- LED CT** 5 000 K, 6 000 K, RGBW*
- ADDITIONAL** acoustic features*, remote control or switch, RAL coating, diffuser print

* options for High Luminous Flux Luminaires Type 27 (h = 200 mm)



VEGA

Vega has a rectangular shape with rounded corners. This luminaire combines simplicity and functionality that perfectly complements modern interiors. Thanks to its stylish design and high light output, Vega produces ample illumination, turning any room into a bright and cozy space.

- HOUSING:** White aluminium luminaire, flexible translucent diffuser. Direct light distribution. High luminous efficiency. Level of illumination is uniform over the entire surface.
- MOUNTING:** 3 installation options, power supply mounted within the housing.
- LAMPING:** LED-technology 24V, CRI > 90.

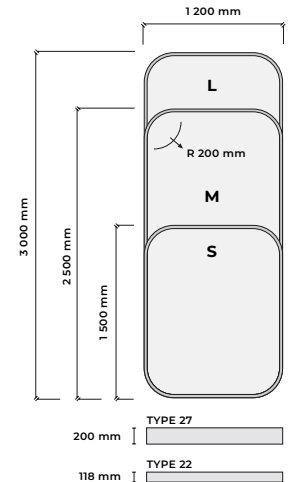

LUMINAIRE VARIATIONS

TYPE 27	TYPE 22
HIGH FLUX (WW / NW / TW)	MEDIUM FLUX (WW / NW)
h = 200 mm	h = 118 mm

* ACOUSTIC

LED SPECIFICATION

LIGHT SOURCE	COLOR TEMP	CRI (RA)
Warm White (WW)	3 000 K	> 90
Neutral White (NW)	4 000 K	> 90
Tunable White (TW)*	2 700 - 6 500 K	> 90

DIMENSIONS	TYPE 27		TYPE 22	
	HIGH FLUX (for NW)	POWER CONSUMPTION	MEDIUM FLUX (for NW)	POWER CONSUMPTION
S 1 200 x 1 500 mm	≈ 21 965 LM	343 W	≈ 9 256 LM	148 W
M 1 200 x 2 500 mm	≈ 39 940 LM	577 W	≈ 16 200 LM	260 W
L 1 200 x 3 000 mm	≈ 44 428 LM	694 W	≈ 19 488 LM	312 W

FEATURES:

- HOUSING COLOR** white
- CONTROL PROTOCOL** dimming 0/1-10 V
- LED CT** WW / NW / TW*

OPTIONAL:

- SIZE** unlimited
- CONTROL PROTOCOL** DALI 2, DMX*
- LED CT** 5 000 K, 6 000 K, RGBW*
- ADDITIONAL** acoustic features*, remote control or switch, RAL coating, diffuser print

* options for High Luminous Flux Luminaires Type 27 (h = 200 mm)



SALSA

Salsa is an oval-shaped luminaire with a simple and concise design. It has a large light scattering surface, which can satisfy the most demanding requirements for lighting the required surfaces. Great for offices, public spaces, trading areas as well as for residential premises.

- HOUSING:** White aluminium luminaire, flexible translucent diffuser. Direct light distribution. High luminous efficiency. Level of illumination is uniform over the entire surface.
- MOUNTING:** 3 installation options, power supply mounted within the housing.
- LAMPING:** LED-technology 24V, CRI > 90.

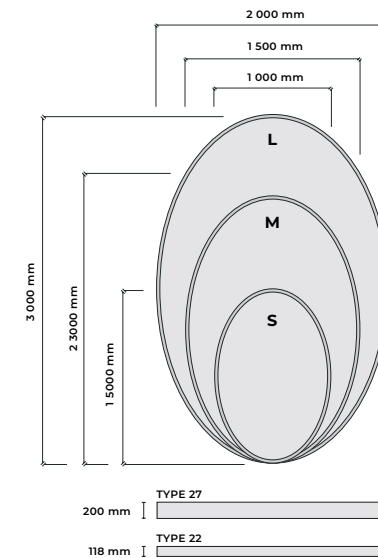

LUMINAIRE VARIATIONS

TYPE 27	TYPE 22
HIGH FLUX (WW / NW / TW)	MEDIUM FLUX (WW / NW)
h = 200 mm	h = 118 mm

* ACOUSTIC

LED SPECIFICATION

LIGHT SOURCE	COLOR TEMP	CRI (RA)
Warm White (WW)	3 000 K	> 90
Neutral White (NW)	4 000 K	> 90
Tunable White (TW)*	2 700 - 6 500 K	> 90

DIMENSIONS	TYPE 27		TYPE 22	
	HIGH FLUX (for NW)	POWER CONSUMPTION	MEDIUM FLUX (for NW)	POWER CONSUMPTION
S 1 000 x 1 500 mm	≈ 14 976 LM	234 W	≈ 5 360 LM	110 W
M 1 500 x 2 300 mm	≈ 33 197 LM	562 W	≈ 14 128 LM	230 W
L 2 000 x 3 000 mm	≈ 59 405 LM	967 W	≈ 25 090 LM	433 W

FEATURES:

- HOUSING COLOR** white
- CONTROL PROTOCOL** dimming 0/1 - 10 V
- LED CT** WW / NW / TW*

OPTIONAL:

- SIZE** unlimited
- CONTROL PROTOCOL** DALI 2, DMX*
- LED CT** 5 000 K, 6 000 K, RGBW*
- ADDITIONAL** acoustic features*, remote control or switch, RAL coating, diffuser print

* options for High Luminous Flux Luminaires Type 27 (h = 200 mm)





MIRA

Mira is a ceiling luminaire of an unusual shape. Among the advantages, one can note an attractive design, an abundance of emitted light and ease of integration into a laconic interior. Its shape is reminiscent of a leaf or a lemon, which will certainly not leave your imagination indifferent. An interesting effect can be achieved by combining this type of lamps of different sizes.

- HOUSING:** White aluminium luminaire, flexible translucent diffuser. Direct light distribution. High luminous efficiency. Level of illumination is uniform over the entire surface.
- MOUNTING:** 3 installation options, power supply mounted within the housing.
- LAMPING:** LED-technology 24V, CRI > 90.

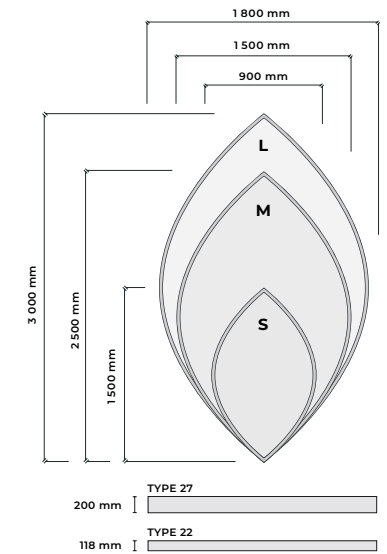

LUMINAIRE VARIATIONS

TYPE 27	TYPE 22
HIGH FLUX (WW / NW / TW)	MEDIUM FLUX (WW / NW)
h = 200 mm	h = 118 mm

* ACOUSTIC

LED SPECIFICATION

LIGHT SOURCE	COLOR TEMP	CRI (RA)
Warm White (WW)	3 000 K	> 90
Neutral White (NW)	4 000 K	> 90
Tunable White (TW)*	2 700 - 6 500 K	> 90

DIMENSIONS	TYPE 27		TYPE 22	
	HIGH FLUX (for NW)	POWER CONSUMPTION	MEDIUM FLUX (for NW)	POWER CONSUMPTION
S 900 x 1 500 mm	≈ 11 232 LM	180 W	≈ 4 628 LM	88 W
M 1 500 x 2 500 mm	≈ 31 200 LM	515 W	≈ 13 032 LM	220 W
L 1 800 x 3 000 mm	≈ 45 677 LM	740 W	≈ 19 488 LM	355 W

FEATURES:

- HOUSING COLOR** white
- CONTROL PROTOCOL** dimming 0/1 - 10 V
- LED CT** WW / NW / TW*

OPTIONAL:

- SIZE** unlimited
- CONTROL PROTOCOL** DALI 2, DMX*
- LED CT** 5 000 K, 6 000 K, RGBW*
- ADDITIONAL** acoustic features*, remote control or switch, RAL coating, diffuser print

* options for High Luminous Flux Luminaires Type 27 (h = 200 mm)





CROWN

The interesting shape of this panel allows you to embody the most creative design solutions in the interior. You can use it either alone or in combination with multiple panels, experimenting with different sizes. Excellent contrast is possible when combined with a round luminaire from our product range with a full illumination surface. Another cool feature of this luminaire is the ability to make the sides different in height, creating a concave inward or convex outside ring and adding even more possibilities for the realization of design fantasies.

- HOUSING:** White aluminium luminaire, flexible translucent diffuser. Direct light distribution. High luminous efficiency. Level of illumination is uniform over the entire surface.
- MOUNTING:** 3 installation options, power supply mounted within the housing.
- LAMPING:** LED-technology 24V, CRI > 90.

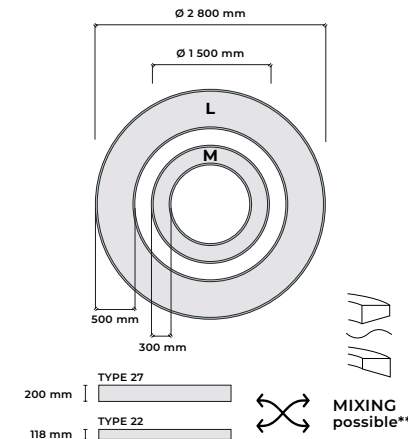

LUMINAIRE VARIATIONS

TYPE 27	TYPE 22
HIGH FLUX (WW / NW / TW)	MEDIUM FLUX (WW / NW)
h = 200 mm	h = 118 mm

* ACOUSTIC

LED SPECIFICATION





LIGHT SOURCE	COLOR TEMP	CRI (RA)
Warm White (WW)	3 000 K	> 90
Neutral White (NW)	4 000 K	> 90
Tunable White (TW)*	2 700 - 6 500 K	> 90

	TYPE 27		TYPE 22	
DIMENSIONS	HIGH FLUX (for NW)	POWER CONSUMPTION	MEDIUM FLUX (for NW)	POWER CONSUMPTION
M 1 500 x 1 500 mm	≈ 11 730 LM	187 W	≈ 5 970 LM	95 W
L 2 800 x 2 800 mm	≈ 44 430 LM	694 W	≈ 17 052 LM	273 W

FEATURES:

-  **HOUSING COLOR** white
-  **CONTROL PROTOCOL** dimming 0/1 - 10 V
-  **LED CT** WW / NW / TW*

OPTIONAL:

-  **SIZE** unlimited
-  **CONTROL PROTOCOL** DALI 2, DMX*
-  **LED CT** 5 000 K, 6 000 K, RGBW*
-  **ADDITIONAL** acoustic features*, remote control or switch, RAL coating, diffuser print

* options for High Luminous Flux Luminaires Type 27 (h = 200 mm)



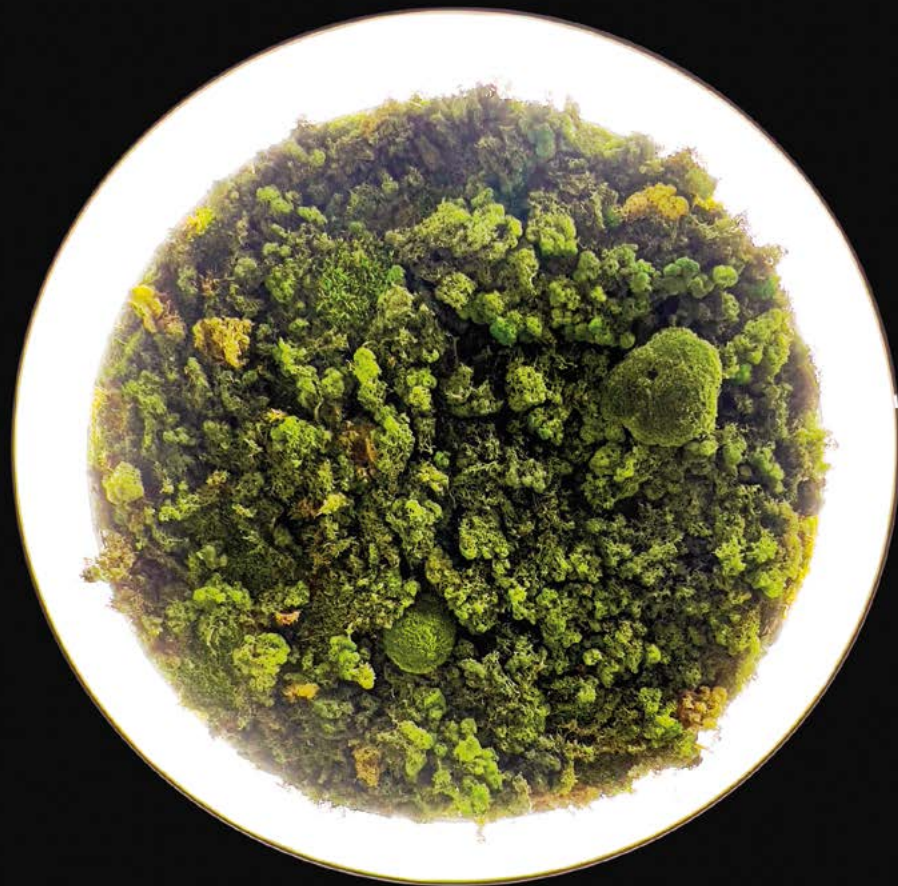

CROWN MOSS

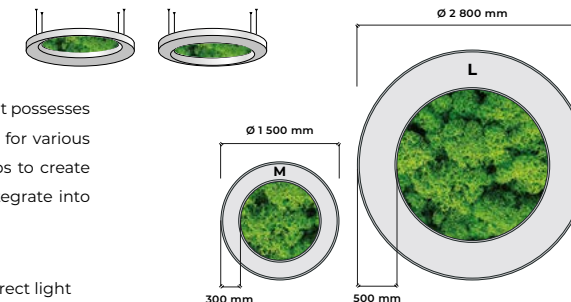

ASA

Luminaire Crown Moss is a composition of natural moss and an LED lamp. It possesses decorative properties combined with modern lighting functions suitable for various types of premises. This lamp can be used both individually and in groups to create lighting zones and compositions within the interior. It will seamlessly integrate into interiors designed in the Scandinavian, hi-tech or minimalistic styles.

- HOUSING:** White aluminium luminaire, flexible translucent diffuser. Direct light distribution. High luminous efficiency. Level of illumination is uniform over the entire surface.
- MOUNTING:** 3 installation options, power supply mounted within the housing.
- LAMPING:** LED-technology 24V, CRI > 90.



LUMINAIRE VARIATIONS

TYPE 27	TYPE 22
HIGH FLUX (WW / NW / TW)	MEDIUM FLUX (WW / NW)
h = 200 mm	h = 118 mm

* ACOUSTIC

LED SPECIFICATION

LIGHT SOURCE	COLOR TEMP	CRI (RA)
Warm White (WW)	3 000 K	> 90
Neutral White (NW)	4 000 K	> 90
Tunable White (TW)*	2 700 - 6 500 K	> 90

	TYPE 27		TYPE 22	
DIMENSIONS	HIGH FLUX (for NW)	POWER CONSUMPTION	MEDIUM FLUX (for NW)	POWER CONSUMPTION
M 1 500 x 1 500 mm	≈ 11 730 LM	187 W	≈ 5 970 LM	95 W
L 2 800 x 2 800 mm	≈ 44 430 LM	694 W	≈ 17 052 LM	273 W

FEATURES:

- HOUSING COLOR** white
- DECOR** stabilized moss
- CONTROL PROTOCOL** dimming 0/1 - 10 V
- LED CT** WW / NW / TW*
- ** TYPE 22 AND 27 MIXING** H 200 with H 118

OPTIONAL:

- SIZE** unlimited
- DECOR** flexible membrane / empty
- CONTROL PROTOCOL** DALI 2, DMX*
- LED CT** 5 000 K, 6 000 K, RGBW*
- ADDITIONAL** acoustic features*, remote control or switch, RAL coating, diffuser print

* options for High Luminous Flux Luminaires Type 27 (h = 200 mm)



POLO MOSS

Polo Moss is another great option for combining lighting and natural materials. Working with natural textures is always fascinating, and such a lamp undoubtedly adds a unique touch to any design project. It is ideally suited for open spaces and premises with high ceiling.

HOUSING: White aluminium luminaire, flexible translucent diffuser. Direct light distribution. High luminous efficiency. Level of illumination is uniform over the entire surface.

MOUNTING: 3 installation options, power supply mounted within the housing.

LAMPING: LED-technology 24V, CRI > 90.

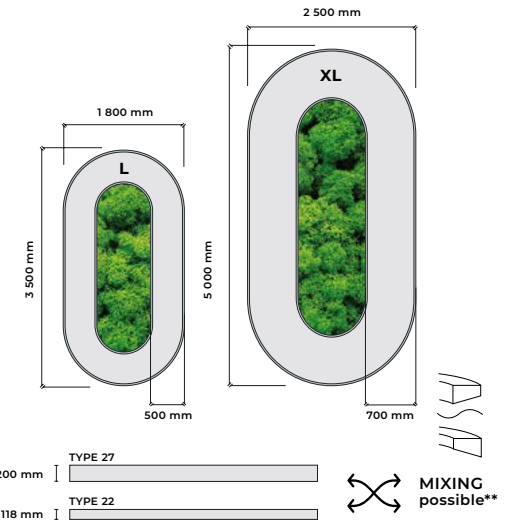

LUMINAIRE VARIATIONS

TYPE 27	TYPE 22
HIGH FLUX (WW / NW / TW)	MEDIUM FLUX (WW / NW)
h = 200 mm	h = 118 mm

* ACOUSTIC

LED SPECIFICATION

LIGHT SOURCE	COLOR TEMP	CRI (RA)
Warm White (WW)	3 000 K	> 90
Neutral White (NW)	4 000 K	> 90
Tunable White (TW)*	2 700 - 6 500 K	> 90

	TYPE 27		TYPE 22	
DIMENSIONS	HIGH FLUX (for NW)	POWER CONSUMPTION	MEDIUM FLUX (for NW)	POWER CONSUMPTION
L 1 800 x 3 500 mm	≈ 46 425 LM	725 W	≈ 17 783 LM	284 W
XL 2 500 x 5 000 mm	≈ 83 865 LM	1310 W	≈ 40 194 LM	643 W

FEATURES:

🏠 HOUSING COLOR	white
💎 DECOR	stabilized moss
⏸ CONTROL PROTOCOL	dimming 0/1 - 10 V
📺 LED CT	WW / NW / TW*
🔄 ** TYPE 22 AND 27 MIXING	H 200 with H 118

OPTIONAL:

📏 SIZE	unlimited
💎 DECOR	flexible membrane / empty
⏸ CONTROL PROTOCOL	DALI 2, DMX*
📺 LED CT	5 000 K, 6 000 K, RGBW*
⌚ ADDITIONAL	acoustic features*, remote control or switch, RAL coating, diffuser print

* options for High Luminous Flux Luminaires Type 27 (h = 200 mm)



VEGA MOSS

This majestic lighting fixture can bring natural beauty and uniqueness to any room. Utilizing its massive size and rectangular shape, this lamp becomes not only a source of illumination, but also an impressive decorative element. The solid construction of the lamp gives it strength and stability, making it a durable and reliable light source.

HOUSING: White aluminium luminaire, flexible translucent diffuser. Direct light distribution. High luminous efficiency. Level of illumination is uniform over the entire surface.

MOUNTING: 3 installation options, power supply mounted within the housing.

LAMPING: LED-technology 24V, CRI > 90.

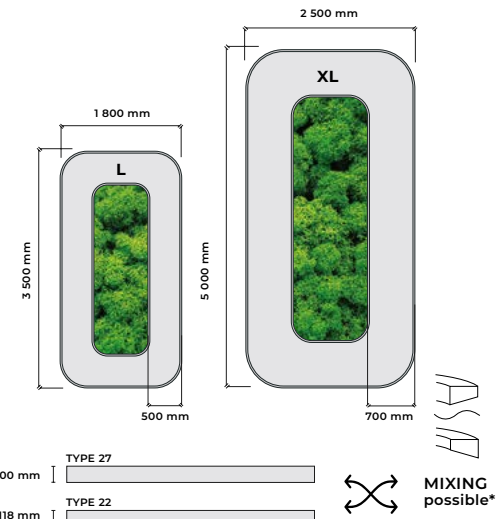

LUMINAIRE VARIATIONS

TYPE 27	TYPE 22
HIGH FLUX (WW / NW / TW)	MEDIUM FLUX (WW / NW)
h = 200 mm	h = 118 mm

* ACOUSTIC

LED SPECIFICATION

LIGHT SOURCE	COLOR TEMP	CRI (RA)
Warm White (WW)	3 000 K	> 90
Neutral White (NW)	4 000 K	> 90
Tunable White (TW)*	2 700 - 6 500 K	> 90

	TYPE 27		TYPE 22	
DIMENSIONS	HIGH FLUX (for NW)	POWER CONSUMPTION	MEDIUM FLUX (for NW)	POWER CONSUMPTION
L 1 800 x 3 500 mm	≈ 49 920 LM	780 W	≈ 18 880 LM	302 W
XL 2 500 x 5 000 mm	≈ 91 354 LM	1427 W	≈ 42 874 LM	686 W

FEATURES:

👉 HOUSING COLOR	white
💎 DECOR	stabilized moss
⏸ CONTROL PROTOCOL	dimming 0/1 - 10 V
📺 LED CT	WW / NW / TW*
🔄 ** TYPE 22 AND 27 MIXING	H 200 with H 118

OPTIONAL:

📏 SIZE	unlimited
💎 DECOR	flexible membrane / empty
⏸ CONTROL PROTOCOL	DALI 2, DMX*
📺 LED CT	5 000 K, 6 000 K, RGBW*
⌚ ADDITIONAL	acoustic features*, remote control or switch, RAL coating, diffusor print

* options for High Luminous Flux Luminaires Type 27 (h = 200 mm)









TECHNICAL INFORMATION

ENVIRONMENTAL AND APPLICATION CONDITIONS

LOCATION	Indoor, any premises
FRAME MATERIAL	Aluminium
DIFFUSER MATERIAL	Easy accessible flexible translucent diffuser
FIRE RATING	CAN/ULC-S102.2/EN:3501-1 Class B
OPERATING ENVIRONMENT (TA)	-25°C to +55°C
STORAGE TEMPERATURE RANGE (TS)	-40°C to +85°C
MAX. OPERATING (CASE) TEMPERATURE (TC)	80°C
DIMMING MODE	Dimmable
VOLTAGE	110 - 240 V
CRI (RA)	CRI (Ra) >90
COLOR UNIFORMITY (TYPICAL)	2 SDCM
LUMEN MAINTENANCE	75,000 hr

SUSPENSION SUGGESTION

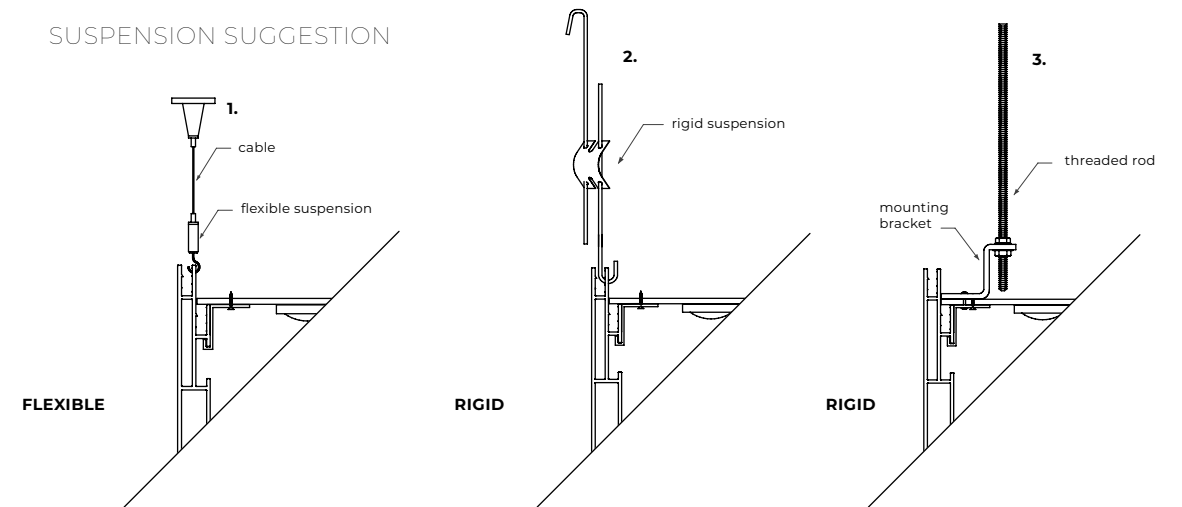



INDIVIDUAL HOUSING

Real wood veneer, leather or powder coating by RAL colors are the best ways to add personality.
Feel free to ask our managers about the possibility of painting and options of decoration.

You can always contact our specialists:

- To check production time
- Request technical documentation for products
- Request tests and certificates
- Inquire about the possibility of making changes to the design
- Order lighting calculation
- Place an order and register your project

Call: **+372 44 23 023**
+372 55 15 394

e-mail: **info@vectadesign.com**

ORDERING INFORMATION

MODEL	NOMINAL SIZE	LUMINOUS FLUX TYPE	COLOR TEMPERATURE	CONTROL PROTOCOLS	HOUSING COLOR	TYPE OF SUSPENSION	ADDITIONAL FEATURES
MODEL NAME	S	TYPE 27 High Flux (h = 200 mm)	NW 4 000 K	DIM dimming 0/1 - 10 V	WHITE	FLEXIBLE cable suspension 4 x 2000 mm	PRINT diffusor with print
	CUSTOM	TYPE 22 Medium Flux (h = 118 mm)	TW 2 700 - 6 500 K	DALI	RAL XXXX desired RAL color code	RIGID mounting bracket	ACOUSTIC* sound absorption *only for TYPE 27
			WW 3 000 K	DALI 2			
			5 000 K	DMX for RGBW			
			6 000 K				
			RGBW				

general features
 optional features

ORDER EXAMPLE:

VEGA + S + TYPE 27 + NW + DIM + WHITE + FLEXIBLE + ACOUSTIC

Vega - S - Type 27 - NW - DIM - White - Flexible - Acoustic



Call: **+372 44 23 023, +372 55 15 394**

Feel free to write: **info@vectadesign.com**

VECTA DESIGN LTD

Pärlimõisa tee 20, Pärnu, 80010 Estonia

+372 44 23 023,
+372 55 15 394

info@vectadesign.com
www.vectadesign.com

