

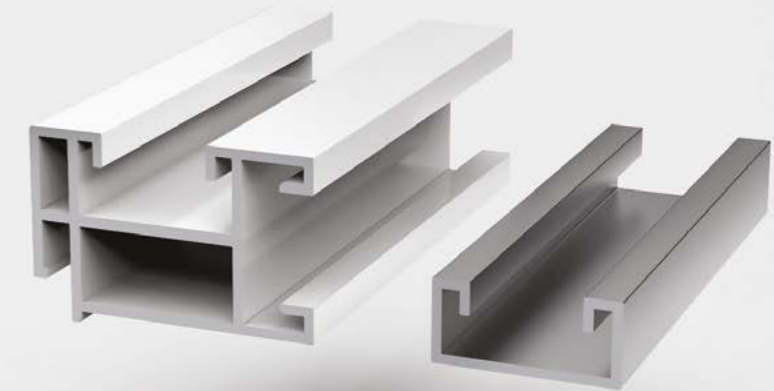

▲ **Das House Commercial Building**
Estonia / Tallinn
Installer: Vecta Design

Commercial Building ▼
Estonia / Tallinn
Installer: Vecta Design



AL 16 and AL 17

Aluminum profiles AL 16W+AL 17 for creating reliable modular constructions and also 3D forms.

AL 16 and 17

Constructive + Modular

THE ADVANTAGES OF AL 16 PROFILE

- Exceptional modular/constructive profile for creating frames in interior design
- This profile is convenient to install and easy to attach with the connection details
- The system enables to have minimum height (33mm) between stretch ceiling and base ceiling

SENSATIONAL OBJECTS DONE WITH THIS PROFILE

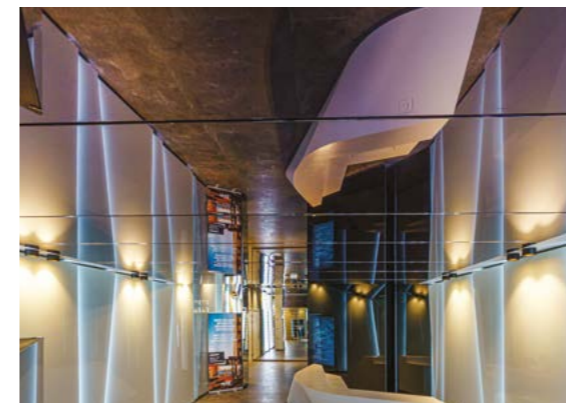

Das House Commercial Building
Estonia / Tallinn
Installer: Vecta Design

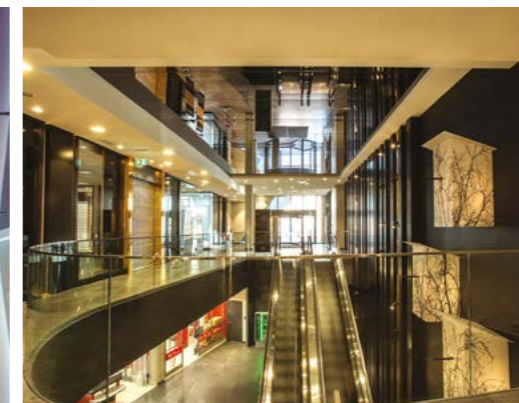

Commercial Building
Estonia / Tallinn
Installer: Vecta Design



Kalev Spa Hotel & Water Park
Estonia / Tallinn
Installer: Vecta Design

PROFILE REAL-SIZE DIMENSIONS

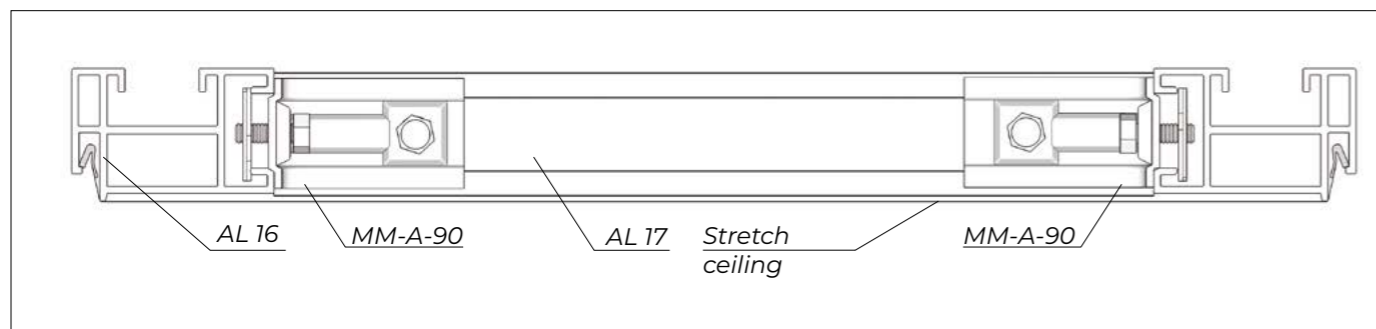
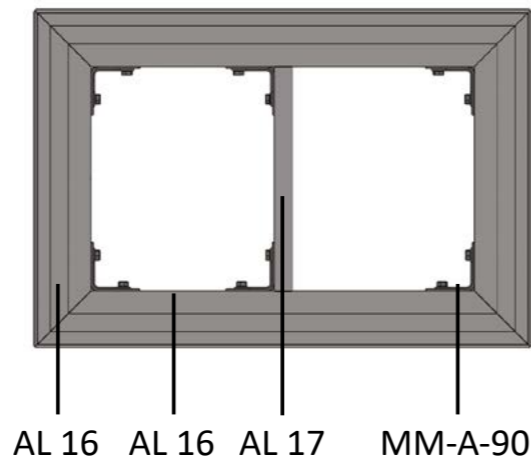
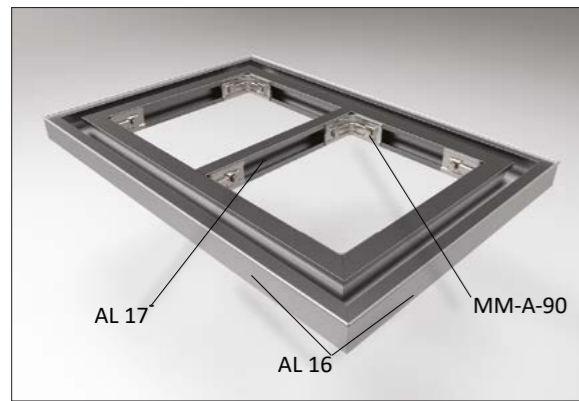
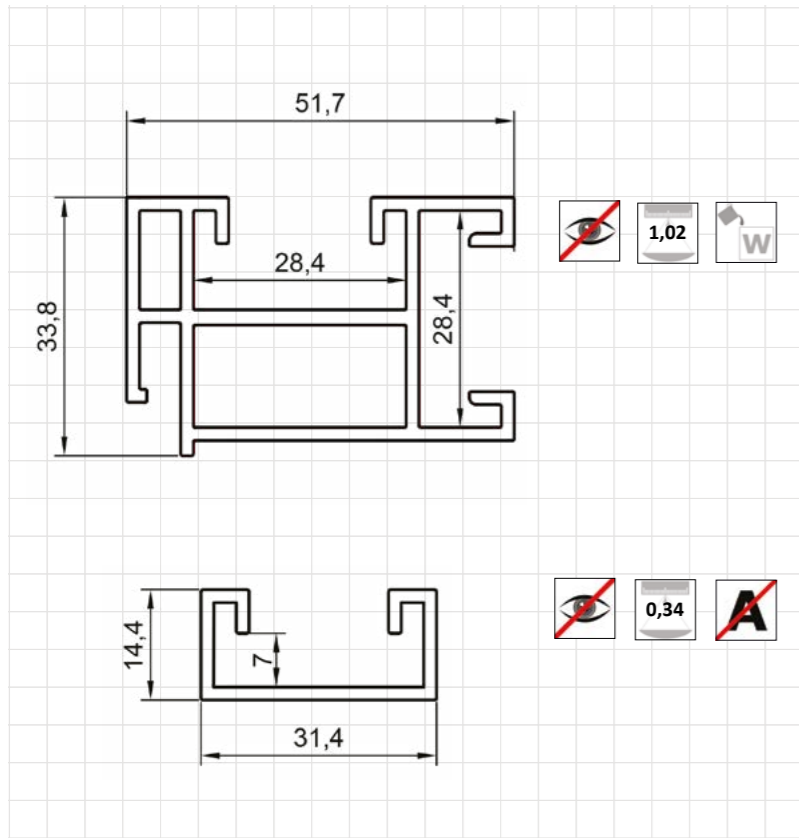

DESCRIPTION

This well-thought system enables to create eye-catching ceiling solutions and aesthetically framed modules. The profiles are strongly fixed with the connection details MM-S, MM-ST, MM-AH-90, and MM-A-90. The stretch ceiling used with this connected profile solution needs to have MINI harpoon, in order for the end result to be visually delightful and for the system to have all its necessary functions in the future – for example the possibility to re-open the ceiling repeatedly in case there is a need for that (water damage or other unexpected cause). Easy corner fixing with LC01 corner mounting elements. Stretch ceilings are made with small reduction using this profile.

CONNECTION DETAILS



Details for the connection of modular profiles:

- Connection MM-S
- Connection MM-ST
- Corner connection MM-AH-90
- Corner connection MM-A-90



CORNER CONNECTION USING LC-01

